



PENGUINS BABY SKIPPER BOX



GETTING STARTED



- Cut solid lines and fold dotted lines.
- Fold all pieces upward or downward along score lines.



INSTRUCTIONS

FLIPPERS, FEET, & BODY

- 1** Cut out FLIPPERS along outer solid line and crease center line and glue shut.

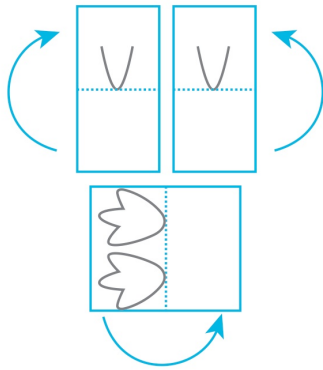

- 2** When dry cut along inner solid lines of FLIPPERS and FEET.

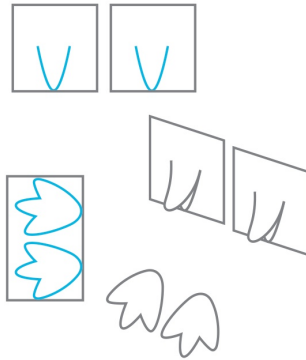

- 3** Cut out BODY. Insert FLIPPERS into slits in sides.

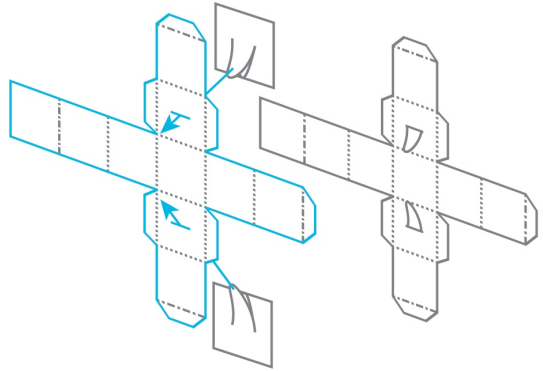

- 4** Mountain fold along horizontal and vertical dotted lines. Glue tabs 1-4 to the inside of the front and back sides.

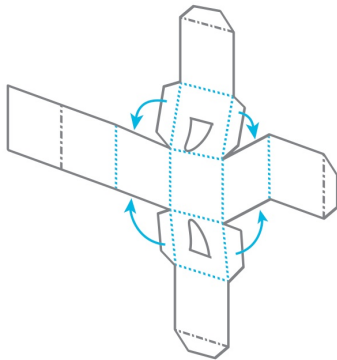

- 5** Fold 3 short sides in. End tabs 5-7 are valley folded so they lay flat in the bottom of the box. Then fold and glue the front side in to the inner bottom of the box and hold the sides in place.

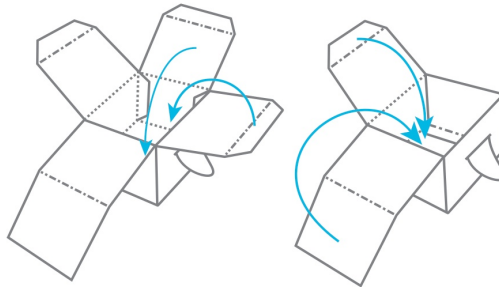

- 6** Apply glue to top of feet and glue to underside of Baby Skipper box.

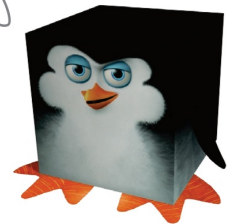
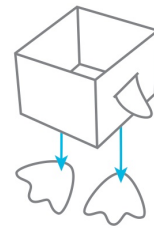

Baby Skipper Box is now complete!